

A?

Aalto University
School of Electrical
Engineering

Small magnetometer for CubeSats

Eija Tanskanen¹, Jouni Envall², Mika Väänänen¹, Hendrik Ehrpais³
Andrew Dimmock⁴, Guan Le⁵

(1) Aalto University, ELEC, Espoo (2) Finnish Meteorological Institute, Helsinki (3) Tartu Observatory, Estonia (4) IRF Uppsala, Sweden (5) NASA/GSFC, US

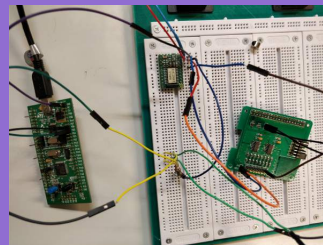
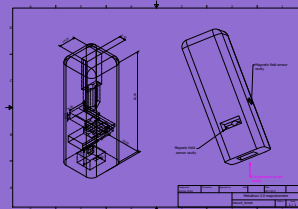

A?

Aalto University
School of Electrical
Engineering

CubeMAG concept

Small and lightweight magnetometers with small power consumption are needed for satellite, ground-based and sea-floor applications.



CubeMAG



GroundMAG



SeaMAG

A?

Aalto University
School of Electrical
Engineering

Magnetometer data

Ground-based magnetic data
for last 150 years ...



... and data from large satellite
missions for slightly over 50 years.

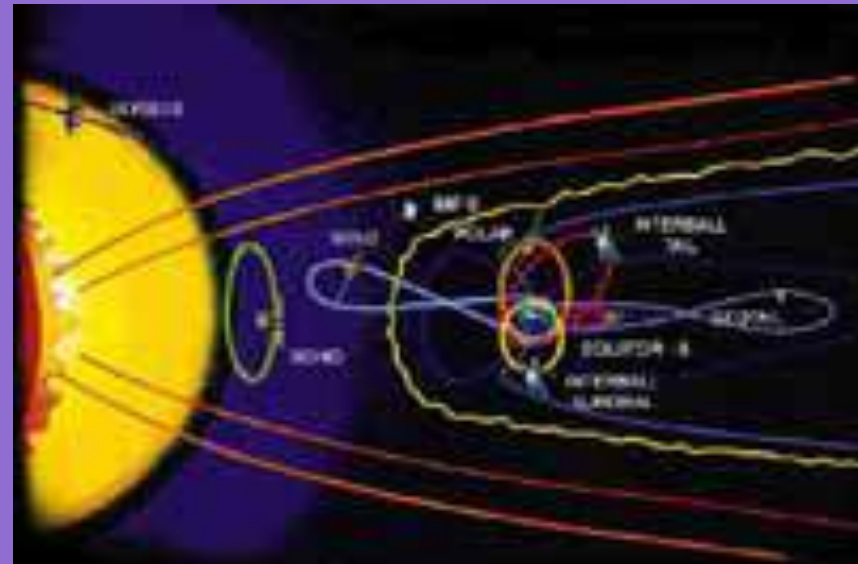

A?

Aalto University
School of Electrical
Engineering

CubeSat magnetometers

CubeSats in magnetosphere and near-Earth space can measure Sun's influence to upper atmosphere.



Magnetometer with boom: CINEMA, ELFIN, INSPIRE, SEAM, AISat

Missions with orientation magnetometer: ESTCube-1, Aalto-1, Aalto-2, Suomi-100, CSSWE, SwissCube, AAUSAT1,2,3, Hello World ...



Aalto University
School of Electrical
Engineering

Miniaturized magnetometer for CubeSats

The first CubeMAG will fly on-board ESTCube-2.

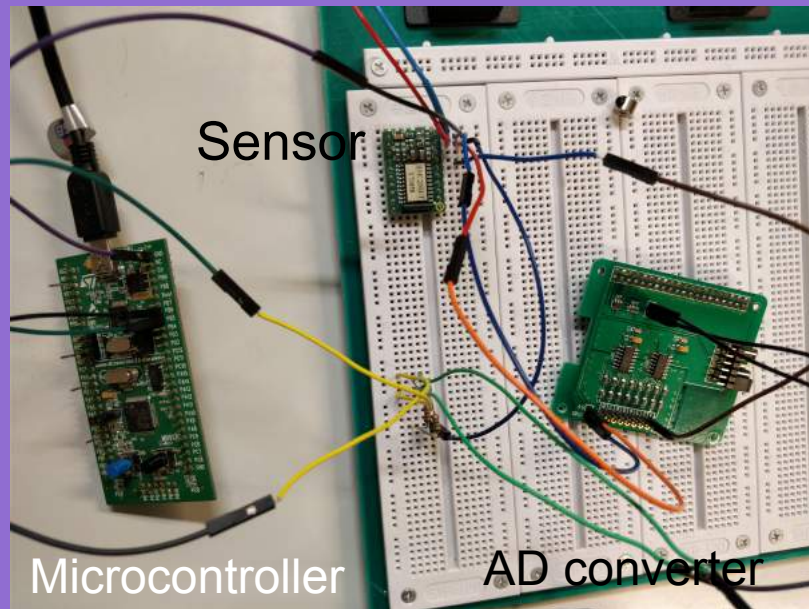

CubeMAG prototype



ESTCube-2



Aalto University
School of Electrical
Engineering

CubeMAG instrument

- Based on HMC2003 3-axis sensor whose analog resolution is 4 nT.
- 24-bit analog-to-digital converter, currently ADS122U04.
- Sensor is controlled by an STM32F100 microcontroller.
- Total mass of the instrument is 6 g.

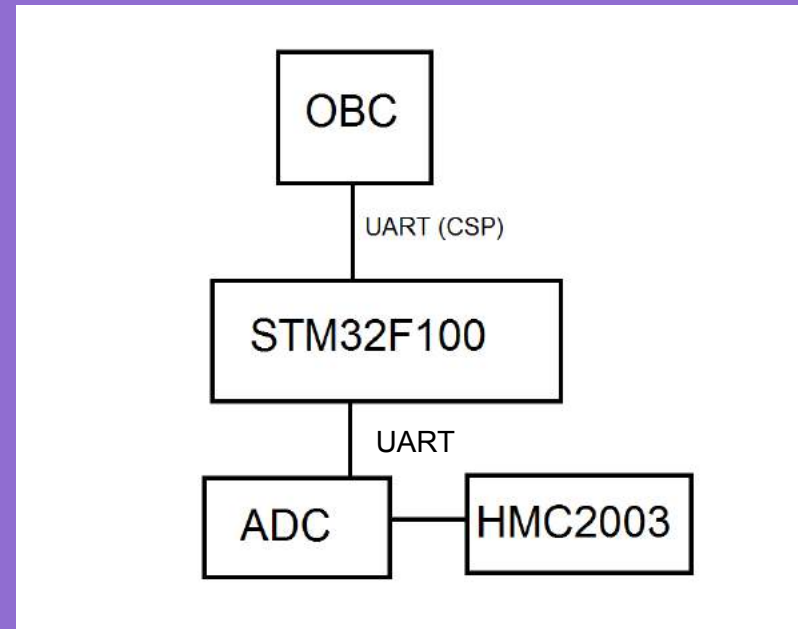

A?

Aalto University
School of Electrical
Engineering

Sensor dimensions

$H = 18.9 \text{ mm}$

$D = 26.6 \text{ mm}$

$A = 11.5 \text{ mm}$

$A1 = 3.2 \text{ mm}$

$e = 2.54 \text{ mm}$

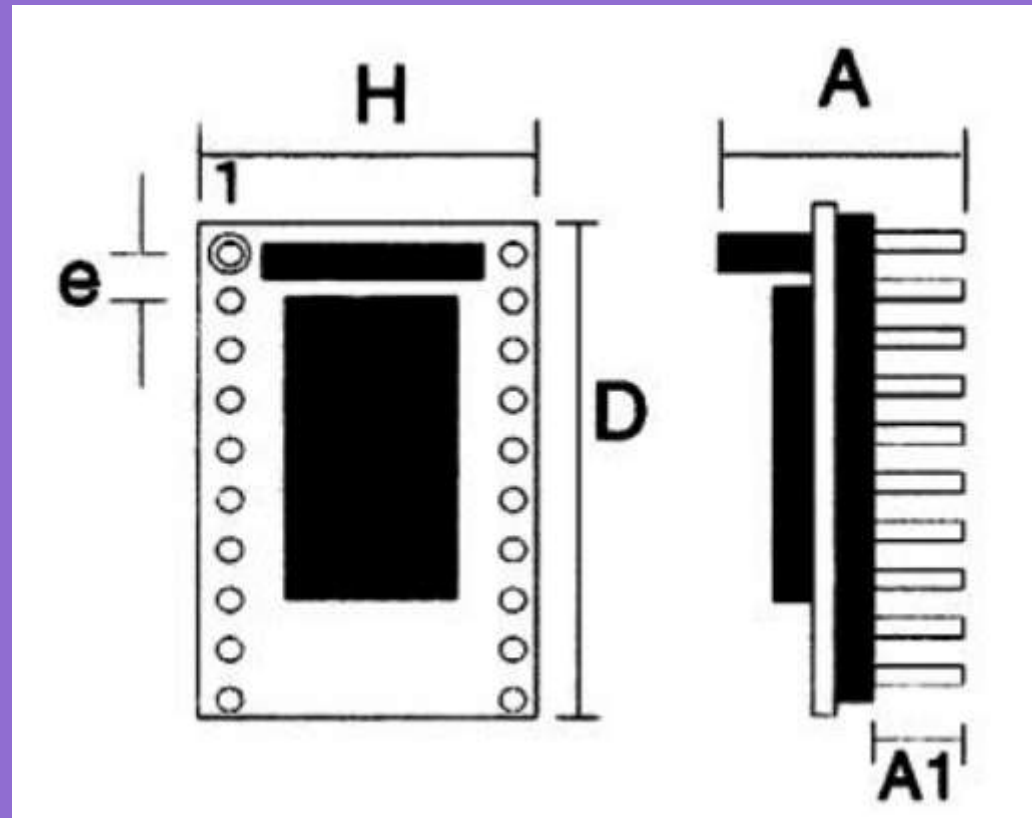



Aalto University
School of Electrical
Engineering

Sensor & ADC details

- Electrical
 - Sensor:
 - Supply voltage 10-12 VDC
 - Supply current 20 mA
 - ADC:
 - Supply voltage 2.3-5.5 VDC
 - Supply current 315 μ A

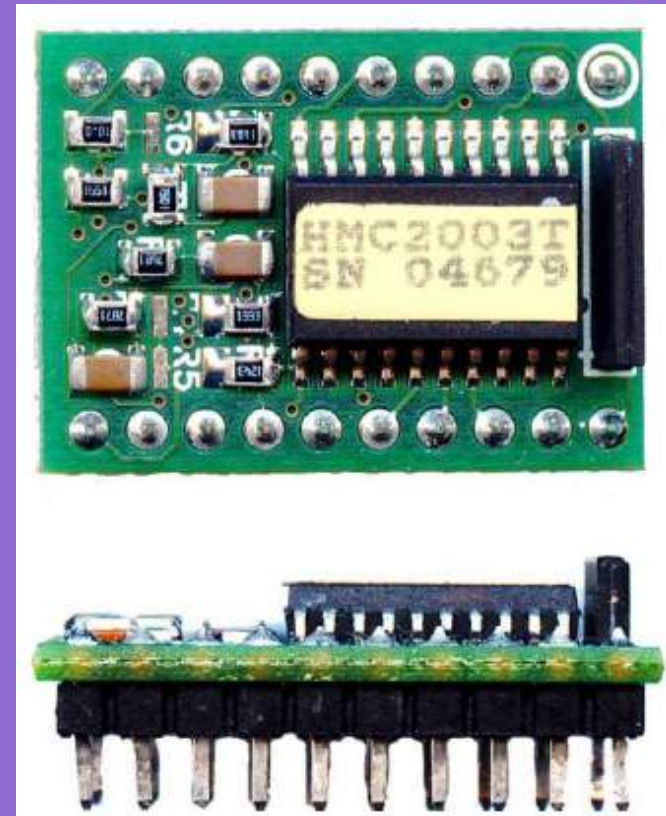

A?

Aalto University
School of Electrical
Engineering

Magnetometer science

Magnetic data is needed for monitoring magnetic disturbances in different parts of the magnetosphere, heliosphere and beyond e.g. solar magnetic fields, solar storms, magnetic clouds, solar wind helicity, geomagnetic storms and substorms.

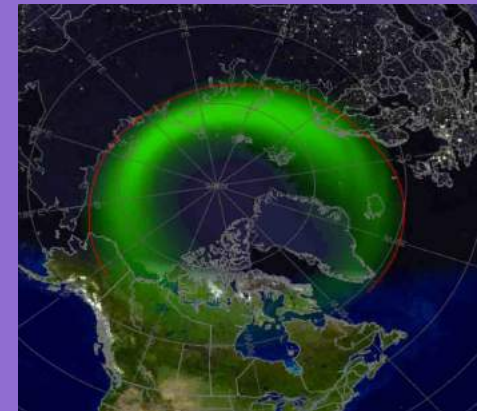
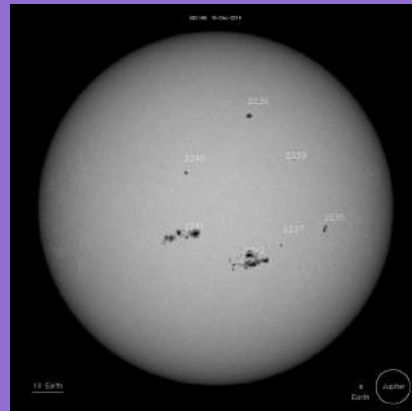
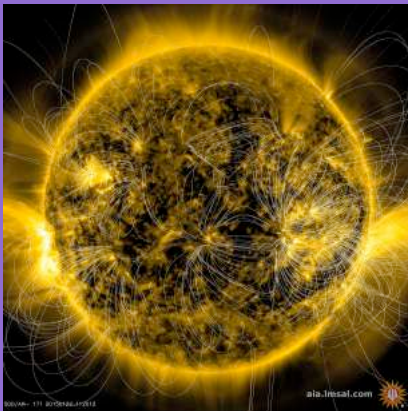



Aalto University
School of Electrical
Engineering

CubeMAG data

- * ADC sample rate: 1 kS/s
- * Each measurement
 - 3 magnetic field axes + timestamp
 - 3 x 24 bits + size of timestamp (16/32 bits)

- Total data rate 88 to 104 bits per sample
- Can be used for monitoring upper atmospheric magnetic fluctuations.

A?

Aalto University
School of Electrical
Engineering

Exospheric magnetic fluctuations cause problems

- Exospheric, ionospheric and ground-based magnetic fluctuations cause trouble to infrastructure in space and on ground.
- Magnetic fluctuations and currents generated by them disturb long ground structures such as power networks and gas pipelines, as well as oil drilling, navigation (automatic cars), telecommunication, nuclear power plants, satellites and cause secondary societal effects.

